

60A 100V SchottkyBarrierDiode

1 Description

Dual center tab Schottky rectifier suited for High Frequency server and telecom base station SMPS. Packaged in TO-247/3P, this device combines

high current rating and low volume to enhance both reliability and power density of the application.

2 Features

- High junction temperature capability
- Low leakage current
- Low thermal resistance
- High frequency operation
- Avalanche specification

3 Applications

- Switching Power Supply
- Power Switching Circuits
- General Purpose

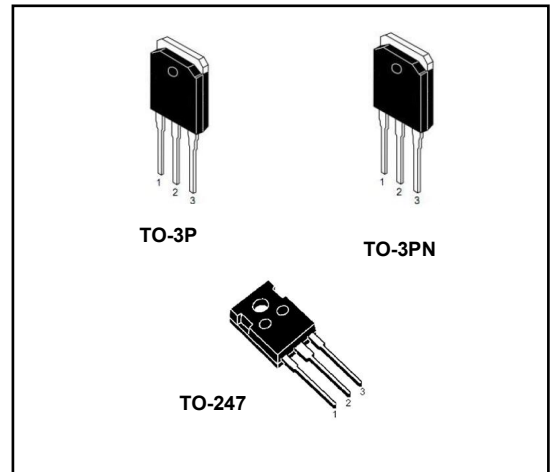
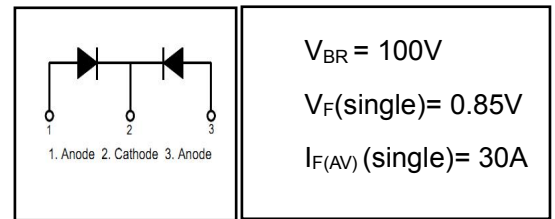

4 Electrical Characteristics

4.1 Absolute Maximum Ratings (T_c=25°C, unless otherwise noted)

PARAMETER		SYMBOL	VALUE	UNIT
Peak Repetitive Reverse Voltage		V_{RRM}	100	V
RMS Reverse Voltage		$V_{R(RMS)}$	80	V
DC Blocking Voltage		V_R	100	V
Average Rectified Forward Current(single)	T _c =120°C	$I_{F(AV)}$	30	A
Average Rectified Forward Current(double)			60	A
Repetitive Peak Surge Current(single)		I_{FRM}	40	A
Nonrepetitive Peak Surge Current(single)	tp=8.3ms	I_{FSM}	350	A
Avalanche Energy(single)	L=1mH	E_{AS}	100	mJ
Operating Junction Temperature Range		T_j	-55~150	°C
Storage Temperature Range		T_{stg}	-55~150	°C

4.2 Thermal Characteristics

PARAMETER	SYMBOL	VALUE		UNIT
		TO-247	TO-3P/3PN	
Thermal Resistance, Junction to Case-sink	R_{thJC}	0.65	0.75	°C/W

4.3 Electrical Characteristics (Tc=25°C, unless otherwise noted)

PARAMETER	SYMBOL	TEST CONDITION	MIN	TYP	MAX	UNIT
Maximum Instantaneous Forward Voltage	V _F	I _F = 30A	-	0.77	0.85	V
		I _F = 30A, T _C = 150°C	-	-	0.73	V
		I _F = 40A	-	0.91	1.1	V
Maximum Instantaneous Reverse	I _R	V _R = 100V	-	7	100	uA
		V _R = 100V, T _C = 125°C	-	-	20	mA
Total capacitance	C _{tot}	V _R =0V f=1MHz	-	1100	-	pF
DC Blocking Voltage	V _{BR}	I _R =100uA	100	125	-	V

DEFINITIONS

V_F = Instantaneous forward voltage (pw = 300μs, D = 2%).

I_R = Instantaneous reverse current.

RθJC = Thermal resistance junction to case.

pw = pulse width.

D = duty cycle.

5 Typical characteristics diagrams

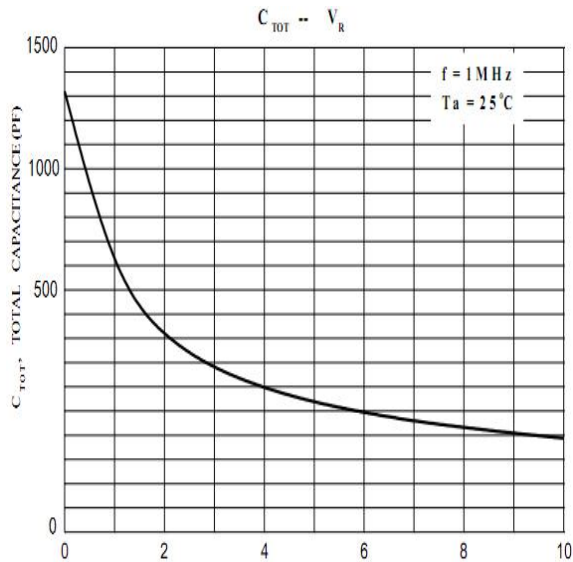

FIGURE 1. Total capacitance vs Voltage

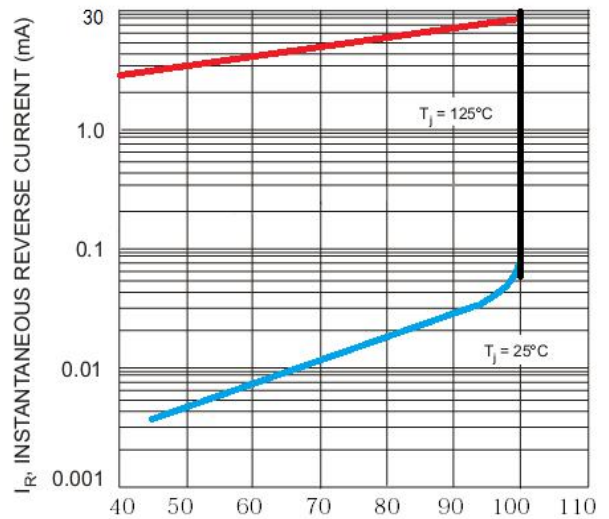

FIGURE 2. REVERSE CURRENT vs REVERSE VOLTAGE

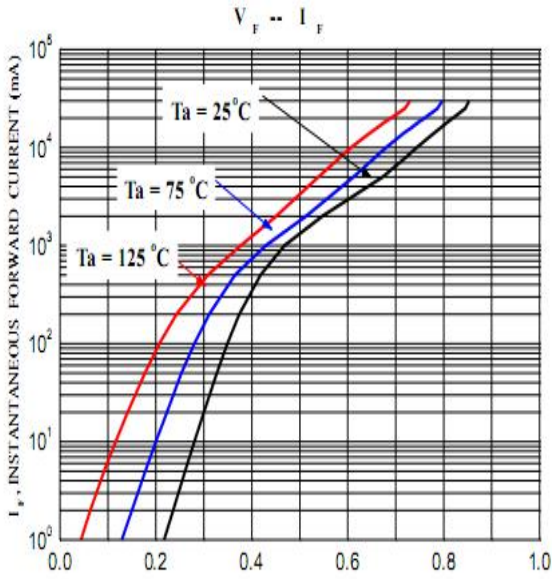
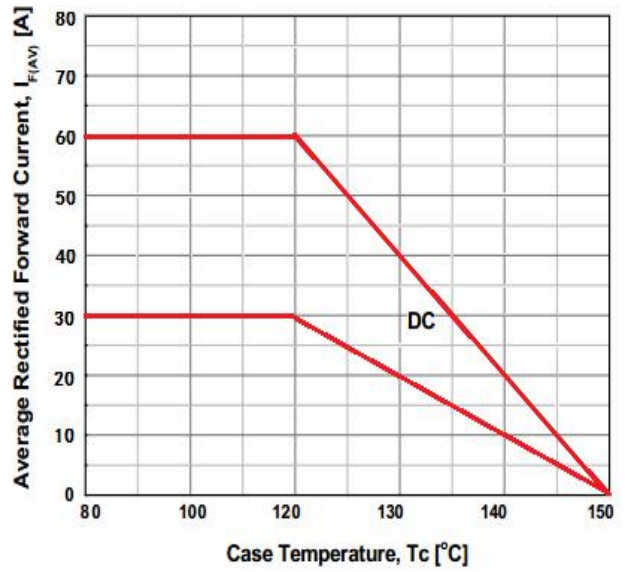

FIGURE 3. FORWARD CURRENT vs FORWARD VOLTAGE



6 Typical Test Circuit and Waveform

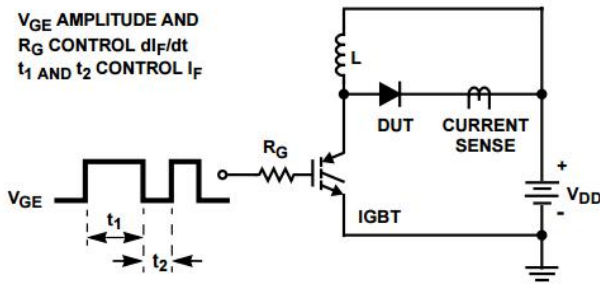

FIGURE 5. trr TEST CIRCUIT

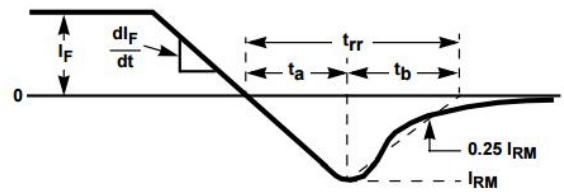

FIGURE 6. trr WAVEFORMS AND DEFINITIONS

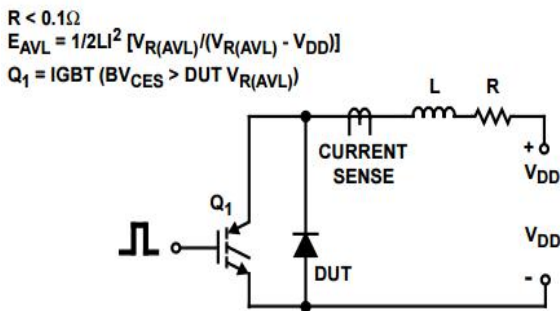

FIGURE 7. AVALANCHE ENERGY TEST CIRCUIT FIGURE

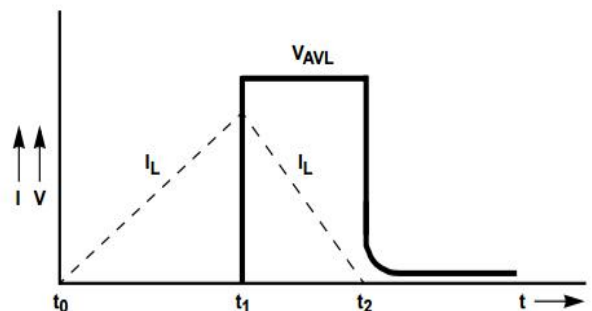
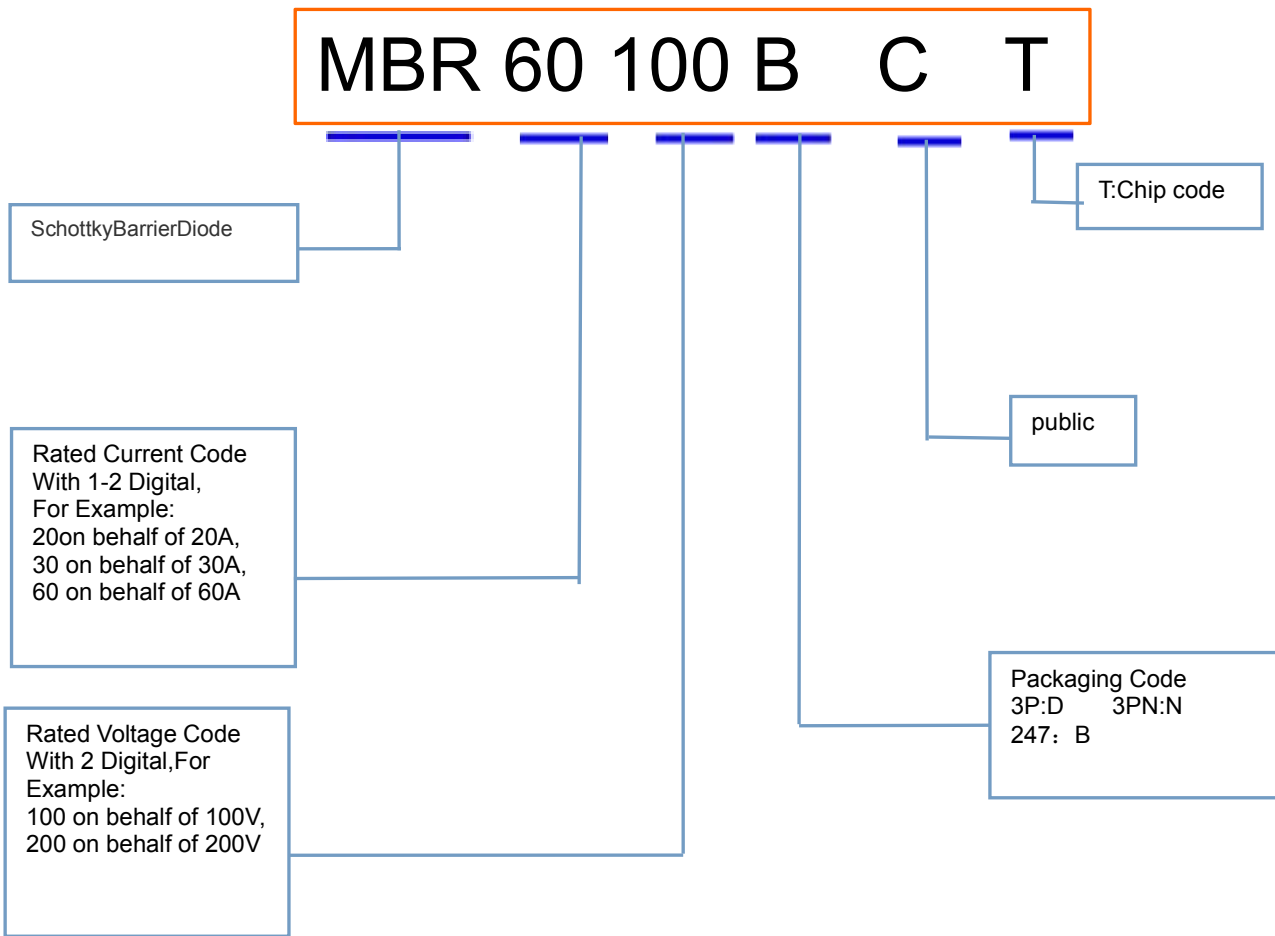

FIGURE 8. AVALANCHE CURRENT AND VOLTAGE WAVEFORMS

7 Product Names Rules



8 Product Specifications and Packaging Models

Product Model	Package Type	Mark Name	RoHS	Package	Quantity
MBR60100CT	TO-3P	MBR60100CT	Pb-free	Tube	300/box
MBR60100BCT	TO-247	MBR60100BCT	Pb-free	Tube	300/box
MBR60100NCT	TO-3P	MBR60100NCT	Pb-free	Tube	300/box

9 Dimensions

TO-247 PACKAGE OUTLINE DIMENSIONS

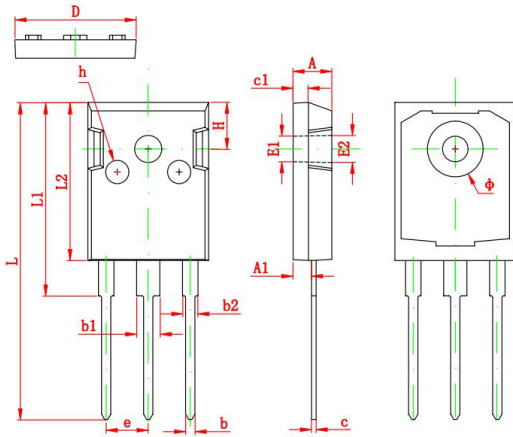

Symbol	Dimensions In Millimeters		Dimensions In Inches	
	Min	Max	Min	Max
A	4.600	5.000	0.181	0.197
A1	2.200	2.600	0.087	0.102
b	0.800	1.200	0.031	0.047
b1	2.800	3.200	0.110	0.126
b2	1.800	2.200	0.071	0.087
c	0.500	0.700	0.020	0.028
c1	1.450	1.650	0.057	0.065
D	15.450	15.850	0.608	0.624
E	13.700	14.100	0.539	0.555
E1	3.200 REF		0.126 REF	
E2	3.300 REF		0.130 REF	
E3	13.450 REF		0.530 REF	
F1	13.400	13.800	0.528	0.543
F2	9.400	9.800	0.370	0.386
L	39.900	40.300	1.571	1.587
L1	23.200	23.600	0.913	0.929
L2	20.300	20.600	0.799	0.811
Φ	6.900	7.100	0.272	0.280
G	5.150	5.550	0.203	0.219
e	5.450 TYP		0.215 TYP	
H	5.000 REF		0.197 REF	
h	0.000	0.300	0.000	0.012

TO-3P PACKAGE OUTLINE DIMENSIONS

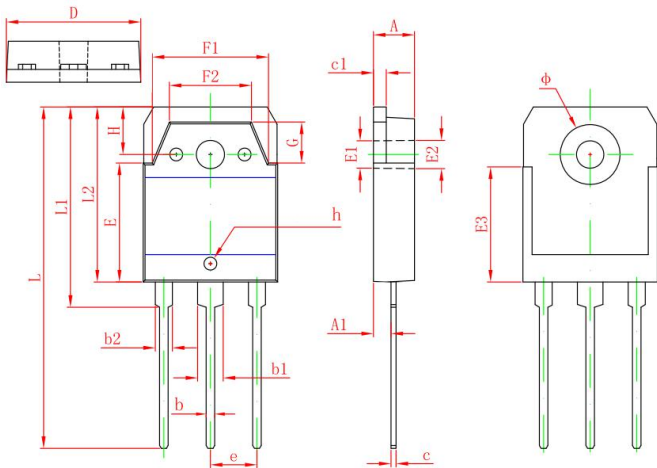

Symbol	Dimensions In Millimeters		Dimensions In Inches	
	Min	Max	Min	Max
A	4.600	5.000	0.181	0.197
A1	2.200	2.600	0.087	0.102
b	0.800	1.200	0.031	0.047
b1	2.800	3.200	0.110	0.126
b2	1.800	2.200	0.071	0.087
c	0.500	0.700	0.020	0.028
c1	1.450	1.650	0.057	0.065
D	15.450	15.850	0.608	0.624
E	13.700	14.100	0.539	0.555
E1	3.200 REF		0.126 REF	
E2	3.300 REF		0.130 REF	
E3	13.450 REF		0.530 REF	
F1	13.400	13.800	0.528	0.543
F2	9.400	9.800	0.370	0.386
L	39.900	40.300	1.571	1.587
L1	23.200	23.600	0.913	0.929
L2	20.300	20.600	0.799	0.811
Φ	6.900	7.100	0.272	0.280
G	5.150	5.550	0.203	0.219
e	5.450 TYP		0.215 TYP	
H	5.000 REF		0.197 REF	
h	0.000	0.300	0.000	0.012

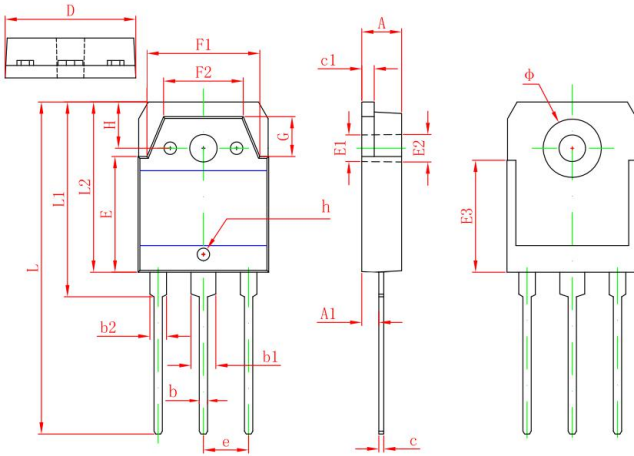
TO-3PN PACKAGE OUTLINE DIMENSIONS

Symbol	Dimensions In Millimeters		Dimensions In Inches	
	Min	Max	Min	Max
A	4.600	5.000	0.181	0.197
A1	2.200	2.600	0.087	0.102
b	0.800	1.200	0.031	0.047
b1	2.800	3.200	0.110	0.126
b2	1.800	2.200	0.071	0.087
c	0.500	0.700	0.020	0.028
c1	1.450	1.650	0.057	0.065
D	15.450	15.850	0.608	0.624
E	13.700	14.100	0.539	0.555
E1	3.200 REF		0.126 REF	
E2	3.300 REF		0.130 REF	
E3	13.450 REF		0.530 REF	
F1	13.400	13.800	0.528	0.543
F2	9.400	9.800	0.370	0.386
L	39.900	40.300	1.571	1.587
L1	23.200	23.600	0.913	0.929
L2	20.300	20.600	0.799	0.811
phi	6.900	7.100	0.272	0.280
G	5.150	5.550	0.203	0.219
e	5.450 TYP		0.215 TYP	
H	5.000 REF		0.197 REF	
h	0.000	0.300	0.000	0.012

10 Attentions

- Jiangsu Donghai Semiconductor Technology Co., Ltd. reserves the right to change the specification without prior notice! The customer should obtain the latest version of the information before making the order and verify that the information is complete and up to date.
- It is the responsibility of the purchaser for any failure or failure of any semiconductor product under certain conditions. It is the responsibility of the purchaser to comply with safety standards and to take safety measures in the system design and machine manufacturing of WXDH products in order to avoid potential risk of failure. Injury or property damage.
- Product promotion is endless, our company will be dedicated to provide customers with better products.

11 Appendix

Revision history:

Date	REV.	Description	Page
2017.10.19	1.0	Original	