

60A 1200V Fast recovery diode

1 Description

60A, 1200V Ultrafast Diodes They have a low forward voltage drop and are of planar, silicon nitride passivated, ion-implanted, epitaxial construction. These devices are intended for use as energy steering/clamping diodes and rectifiers in a variety of switching power supplies and other power switching applications. Their low stored charge and ultrafast recovery with soft recovery characteristics minimizes ringing and electrical noise in many power switching circuits, thus reducing power loss in the switching transistor

2 Features

- Low power loss,
- high efficiency Low forward voltage,
- high current capability High surge capacity
- Super fast recovery times
- high voltage

3 Applications

- Switching Power Supply
- Power Switching Circuits
- Inverter power supply

4 Electrical Characteristics

4.1 Absolute Maximum Ratings (Tc=25°C, unless otherwise noted)

PARAMETER		SYMBOL	VALUE	UNIT
Peak Repetitive Reverse Voltage		V_{RRM}	1200	V
Working Peak Reverse Voltage		V_{RWM}	1200	V
DC Blocking Voltage		V_R	1200	V
Average Rectified Forward Current(single)	Tc=120°C	$I_{F(AV)}$	30	A
Average Rectified Forward Current(double)	Tc=120°C		60	A
Repetitive Peak Surge Current(single)		I_{FRM}	45	A
Nonrepetitive Peak Surge Current(single)	tp=8.3ms	I_{FSM}	250	A
Avalanche Energy(single)	L=1mH	E_{AS}	50	mJ
Operating Junction Temperature Range		T_j	-55~150	°C
Storage Temperature Range		T_{stg}	-55~150	°C

4.2 Thermal Characteristics

PARAMETER	SYMBOL	VALUE		UNIT
		TO-3P/3PN	TO-247	
Thermal Resistance, Junction to Case-sink	R_{thJC}	1.5	1.2	°C/W

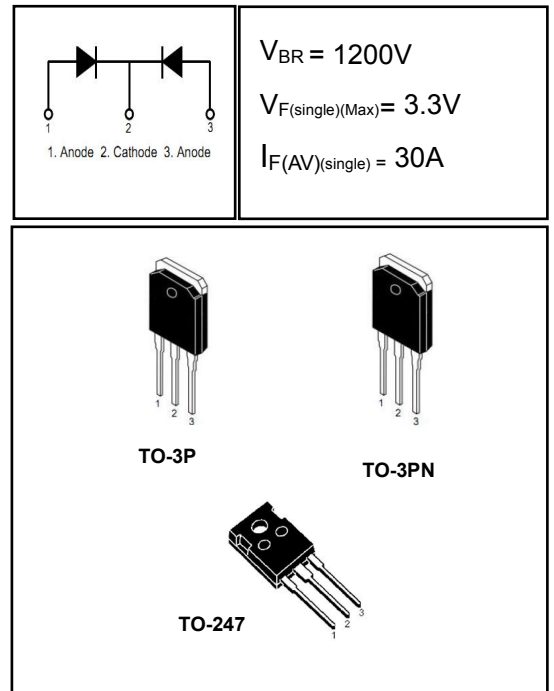

4.3 Electrical Characteristics (Tc=25°C, unless otherwise noted)

PARAMETER	SYMBOL	TEST CONDITION	MIN	TYP	MAX	UNIT
Maximum Instantaneous Forward Voltage	V _F	I _F = 20A		2.50	3.0	V
		I _F = 30A	-	2.85	3.3	V
		I _F = 30A, T _C = 150°C	-	-	3.1	V
		I _F = 40A	-	-	3.5	V
Maximum Instantaneous Reverse	I _R	V _R = 1200V	-	-	5	μA
		V _R = 1200V, T _C = 150°C	-	-	5	mA
Maximum Reverse Recovery Time	t _{rr}	V _R = 30V I _F = 1A -di/dt = 50A/us	-	45	80	ns
Total capacitance	C _{tot}	V _R = 0V f = 1MHz	-	700	-	pF
DC Blocking Voltage	V _{BR}	I _R = 100μA	1200	1330	-	V

DEFINITIONS

V_F = Instantaneous forward voltage (pw = 300μs, D = 2%).

I_R = Instantaneous reverse current.

RθJC = Thermal resistance junction to case.

pw = pulse width.

D = duty cycle.

5 Typical characteristics diagrams

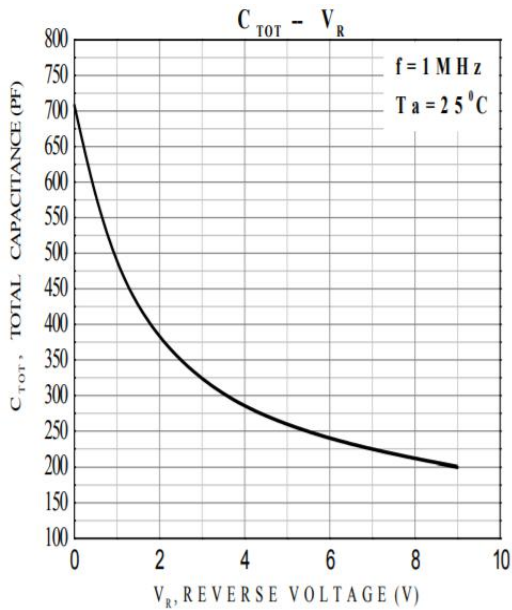

FIGURE 1. Total capacitance vs Voltage

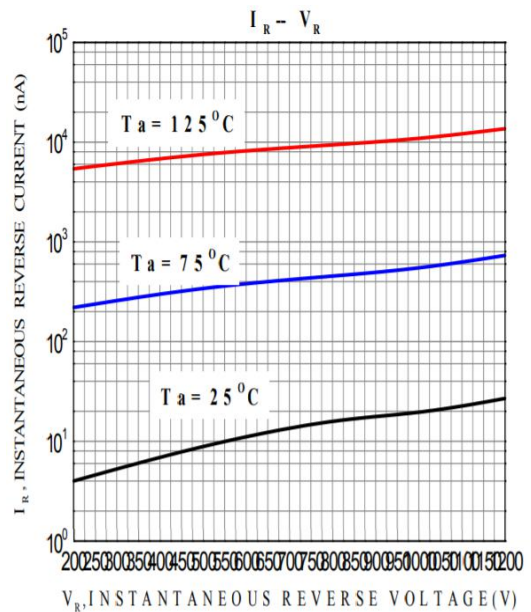

FIGURE 2. REVERSE CURRENT vs REVERSE VOLTAGE

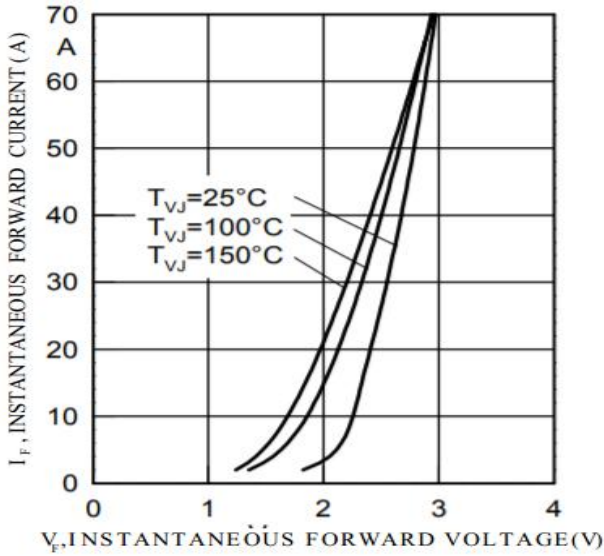

FIGURE 3. FORWARD CURRENT vs FORWARD VOLTAGE

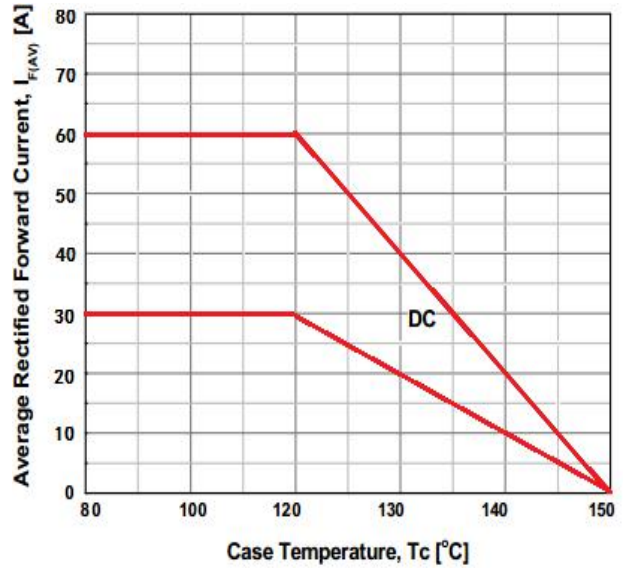

FIGURE 4. CURRENT DERATING CURVE

6 Typical Test Circuit and Waveform

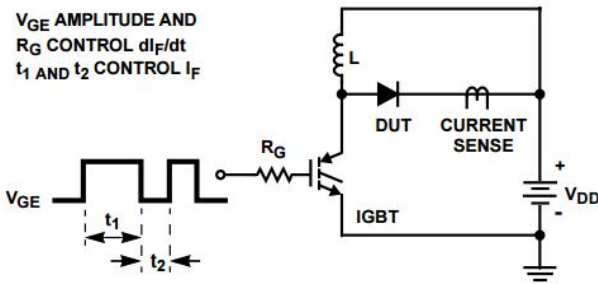

FIGURE 5. trr TEST CIRCUIT

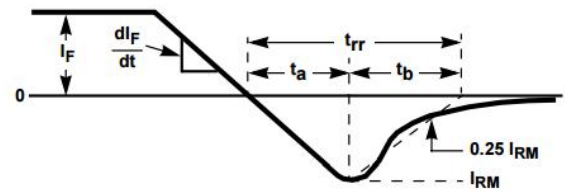

FIGURE 6. trr WAVEFORMS AND DEFINITIONS

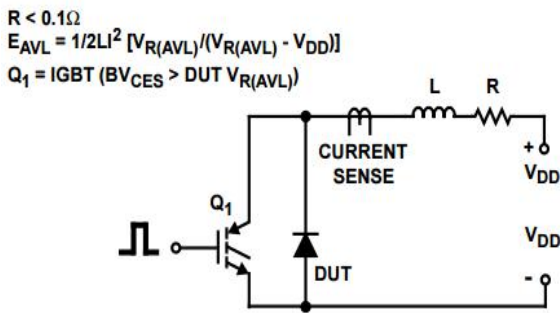

FIGURE 7. AVALANCHE ENERGY TEST CIRCUIT FIGURE

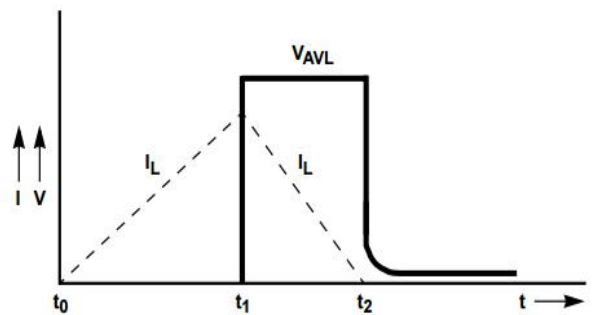
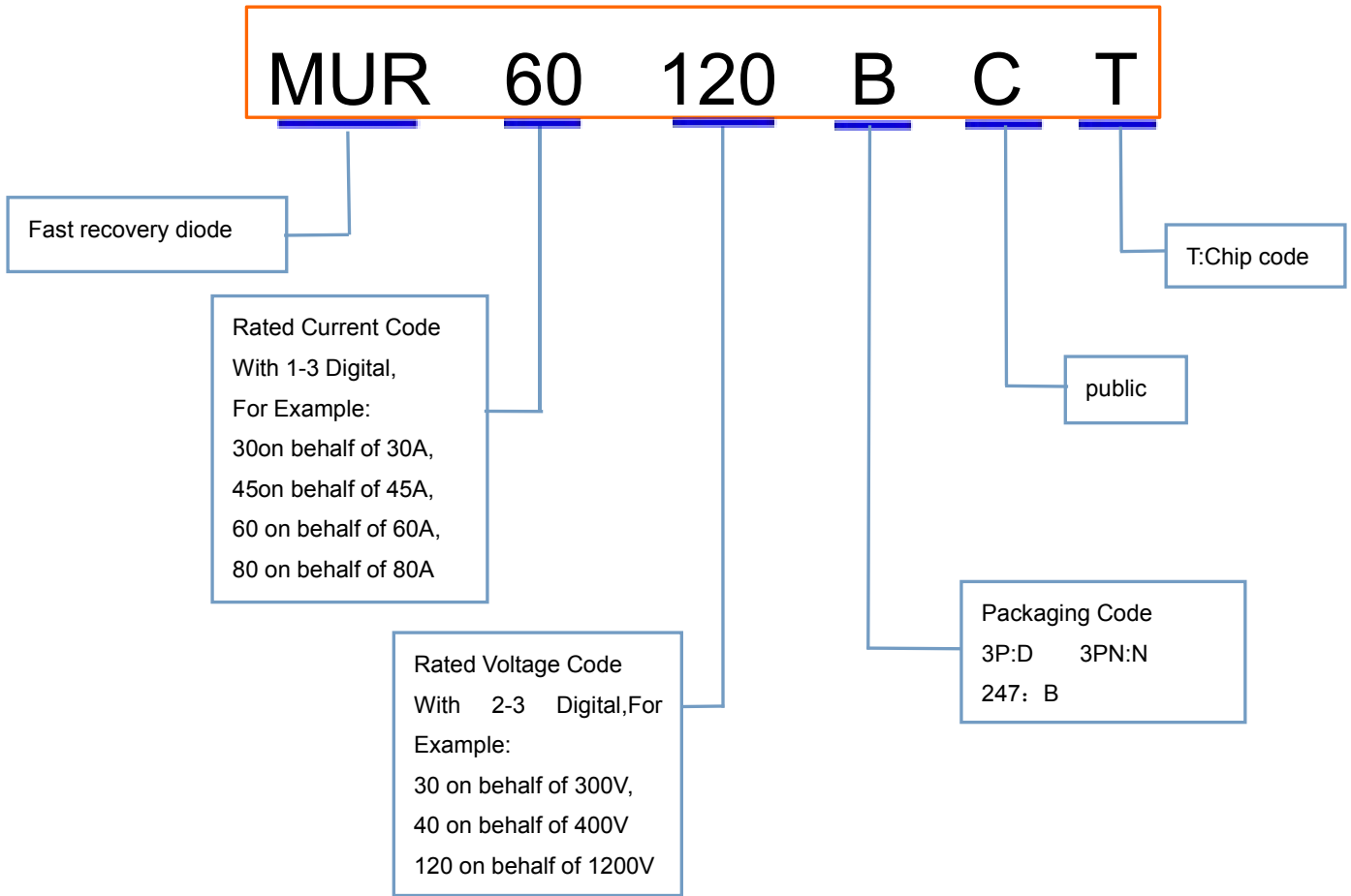

FIGURE 8. AVALANCHE CURRENT AND VOLTAGE WAVEFORMS

7 Product Names Rules



8 Product Specifications and Packaging Models

Product Model	Package Type	Mark Name	RoHS	Package	Quantity
MUR60120DCT	TO-3P	MUR60120DCT	Pb-free	Tube	300/box
MUR60120NCT	TO-3PN	MUR60120NCT	Pb-free	Tube	300/box
MUR60120BCT	TO-247	MUR60120BCT	Pb-free	Tube	300/box

9 Dimensions

TO-247 PACKAGE OUTLINE DIMENSIONS

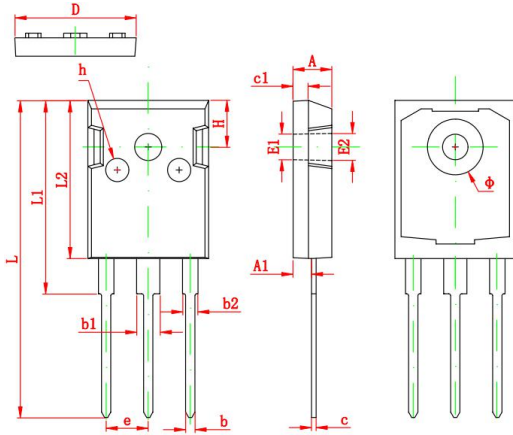

Symbol	Dimensions In Millimeters		Dimensions In Inches	
	Min	Max	Min	Max
A	4.850	5.150	0.191	0.200
A1	2.200	2.600	0.087	0.102
b	1.000	1.400	0.039	0.055
b1	2.800	3.200	0.110	0.126
b2	1.800	2.200	0.071	0.087
c	0.500	0.700	0.020	0.028
c1	1.900	2.100	0.075	0.083
D	15.450	15.750	0.608	0.620
E1	3.500 REF		0.138 REF	
E2	3.600 REF		0.142 REF	
L	40.900	41.300	1.610	1.626
L1	24.800	25.100	0.976	0.988
L2	20.300	20.600	0.799	0.811
Φ	7.100	7.300	0.280	0.287
e	5.450 TYP		0.215 TYP	
H	5.980 REF		0.235 REF	
h	0.000	0.300	0.000	0.012

TO-3P PACKAGE OUTLINE DIMENSIONS

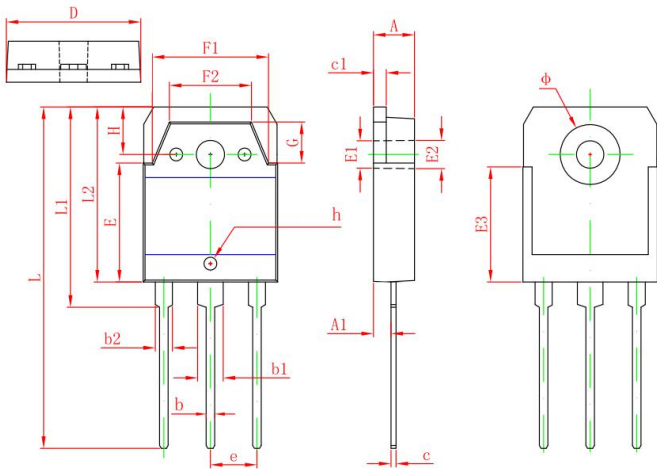

Symbol	Dimensions In Millimeters		Dimensions In Inches	
	Min	Max	Min	Max
A	4.600	5.000	0.181	0.197
A1	2.200	2.600	0.087	0.102
b	0.800	1.200	0.031	0.047
b1	2.800	3.200	0.110	0.126
b2	1.800	2.200	0.071	0.087
c	0.500	0.700	0.020	0.028
c1	1.450	1.650	0.057	0.065
D	15.450	15.850	0.608	0.624
E	13.700	14.100	0.539	0.555
E1	3.200 REF		0.126 REF	
E2	3.300 REF		0.130 REF	
E3	13.450 REF		0.530 REF	
F1	13.400	13.800	0.528	0.543
F2	9.400	9.800	0.370	0.386
L	39.900	40.300	1.571	1.587
L1	23.200	23.600	0.913	0.929
L2	20.300	20.600	0.799	0.811
Φ	6.900	7.100	0.272	0.280
G	5.150	5.550	0.203	0.219
e	5.450 TYP		0.215 TYP	
H	5.000 REF		0.197 REF	
h	0.000	0.300	0.000	0.012

TO-3PN PACKAGE OUTLINE DIMENSIONS

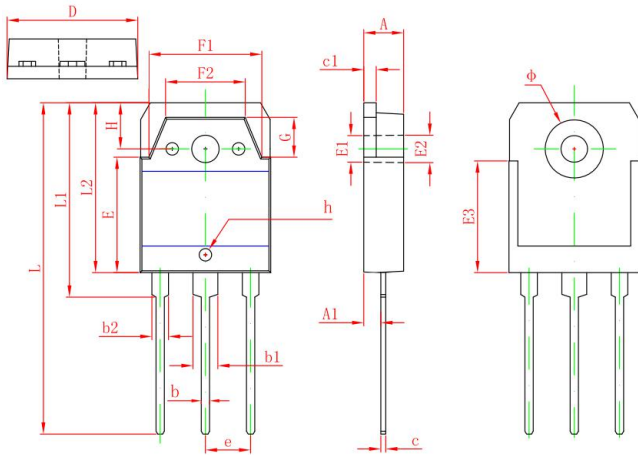

Symbol	Dimensions In Millimeters		Dimensions In Inches	
	Min	Max	Min	Max
A	4.600	5.000	0.181	0.197
A1	2.200	2.600	0.087	0.102
b	0.800	1.200	0.031	0.047
b1	2.800	3.200	0.110	0.126
b2	1.800	2.200	0.071	0.087
c	0.500	0.700	0.020	0.028
c1	1.450	1.650	0.057	0.065
D	15.450	15.850	0.608	0.624
E	13.700	14.100	0.539	0.555
E1	3.200 REF		0.126 REF	
E2	3.300 REF		0.130 REF	
E3	13.450 REF		0.530 REF	
F1	13.400	13.800	0.528	0.543
F2	9.400	9.800	0.370	0.386
L	39.900	40.300	1.571	1.587
L1	23.200	23.600	0.913	0.929
L2	20.300	20.600	0.799	0.811
φ	6.900	7.100	0.272	0.280
G	5.150	5.550	0.203	0.219
e	5.450 TYP		0.215 TYP	
H	5.000 REF		0.197 REF	
h	0.000	0.300	0.000	0.012

10 Attentions

- Jiangsu Donghai Semiconductor Technology Co., Ltd. reserves the right to change the specification without prior notice! The customer should obtain the latest version of the information before making the order and verify that the information is complete and up to date.
- It is the responsibility of the purchaser for any failure or failure of any semiconductor product under certain conditions. It is the responsibility of the purchaser to comply with safety standards and to take safety measures in the system design and machine manufacturing of WXDH products in order to avoid potential risk of failure. Injury or property damage.
- Product promotion is endless, our company will be dedicated to provide customers with better products.

11 Appendix

Revision history:

Date	REV.	Description	Page
2017.09.2	1.0	Original	
208.10.8	1.1	Add to appearance	7 page