

40A 1200V Half bridge module

1 Description

These Insulated Gate Bipolar Transistor used advanced trench and Fieldstop technology design, provided excellent V_{CEsat} and switching speed ,low gate charge. Which accords with the RoHS standard.

2 Features

- FS Trench Technology, Positive temperature coefficient
- Low saturation voltage: $V_{CE(sat)}$, typ = 1.75V @ $I_c = 40A$ and $T_j = 25^\circ C$
- Extremely enhanced avalanche capability

3 Applications

- Welding
- UPS
- Three-level Inverter
- AC and DC servo drive amplifier



Type	V_{CE}	I_c	$V_{CEsat}, T_j=25^\circ C$	T_{jop}	Package
DGA40H120M2T	1200V	40A ($T_j=100^\circ C$)	1.75V (Typ)	150°C	34MM

4 Equivalent Circuit Schematic

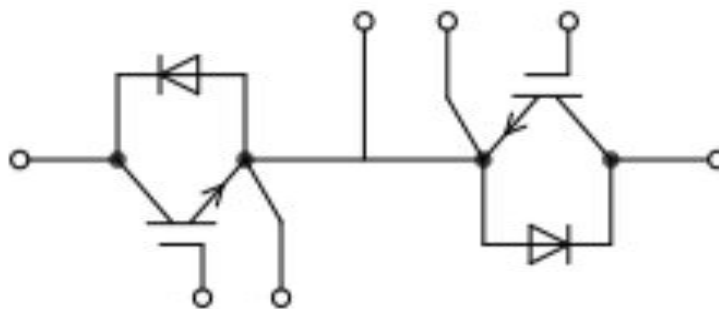

5 Electrical Characteristics

5.1 Absolute Maximum Ratings (IGBT) (Tc=25°C,unless otherwise specified)

Parameter	Symbol	Value	Units
Collector-to-Emitter Voltage	V_{CE}	1200	V
Gate-to-Emitter Voltage	V_{GE}	±30	V
DC Collector current	I_C	$T_j=25^{\circ}C$	80
		$T_j=100^{\circ}C$	40
Pulsed Collector Current #1	I_{CM}	160	A
Short circuit withstand time, $V_{GE}=15V$, $V_{CC}=600V$, Allowed number of short circuits < 1000 Time between short circuits: ≥ 1.0s $T_j=150^{\circ}C$	T_{SC}	10	μs

Notes: #1 Pulse duration is limited by $T_{j,max}$

5.2 Absolute Maximum Ratings (Diode) (Tc=25°C,unless otherwise specified)

PARAMETER	SYMBOL	VALUE	UNIT
Peak Repetitive Reverse Voltage	V_{RRM}	1200	V
DC Blocking Voltage	V_R	1200	V
Average Rectified Forward Current	$I_{F(AV)}$	40	A
Repetitive Peak Surge Current	I_{FRM}	80	A
Nonrepetitive Peak Surge Current(single)	I_{FSM}	200	A
	$t_p=8.3ms$		

5.3 IGBT Module

Parameter	Symbol	VALUE	Units
Junction Temperature Range	T_{jmax}	-45~175	°C
Operating Junction Temperature	T_{jop}	-45~150	°C
Storage Temperature Range	T_{stg}	-45~150	°C
Isolation Voltage $R_{MS}, f=50Hz, t=1min$	V_{ISO}	4000	V

5.4 Thermal Characteristics (IGBT Module)

Parameter	Symbol	Rating	Units
Thermal Resistance Junction to Case	R_{thJC}	IGBT(Each)	0.32
		Diode(Each)	0.61

5.5 Electrical Characteristics (IGBT) (Tc=25°C, unless otherwise specified)

Parameter	Symbol	Conditions	Value			Units
			Min	Typ	Max	
Static Characteristics						
Collector-to-Emitter Breakdown Voltage	$V_{(BR)CES}$	$I_C=250\mu A, V_{GE}=0V, T_j=25^\circ C$	1200	1380	--	V
Collector-to-Emitter Leakage Current	I_{CES}	$V_{CE}=1200V, V_{GE}=0V, T_j=25^\circ C$	--	--	10	μA
		$V_{CE}=1200V, V_{GE}=0V, T_j=150^\circ C$	--	--	2	mA
Gate-to-Emitter Leakage Current	I_{GES}	$V_{GE}=\pm 30V, V_{CE}=0V, T_j=25^\circ C$	--	--	± 100	nA
		$V_{GE}=\pm 30V, V_{CE}=0V, T_j=150^\circ C$	--	--	± 200	nA
Gate Threshold Voltage	$V_{GE(th)}$	$V_{CE}=V_{GE}, I_C=250\mu A$	4.5	5.5	6.5	V
Collector-emitter saturation voltage	V_{CEsat}	$V_{GE}=15V, I_C=40A, T_j=25^\circ C$	--	1.75	2.0	V
		$V_{GE}=15V, I_C=40A, T_j=150^\circ C$	--	2.1	2.5	V
Dynamic Characteristics						
Input Capacitance	C_{iss}	$V_{CE}=25V, V_{GE}=0V, f=1MHz, T_a=25^\circ C$	--	6483	--	pF
Output Capacitance	C_{oss}		--	187	--	
Reverse Transfer Capacitance	C_{rss}		--	39	--	
IGBT Characteristics						
Turn-on delay time	$t_{d(on)}$	$V_{CE}=600V, I_C=40A, R_G=10\Omega, V_{GE}=15V, \text{感性负载}, T_C=25^\circ C$	--	40	--	nS
Rise time	t_r		--	36	--	nS
Turn-off delay time	$t_{d(off)}$		--	372	--	nS
Fall time	t_f		--	114	--	nS
Turn-on energy	E_{on}		--	0.94	--	mJ
Turn-off energy	E_{off}		--	2.53	--	mJ
Total switching energy	E_{ts}	--	3.47	--	mJ	
Turn-on delay time	$t_{d(on)}$	$V_{CE}=600V, I_C=40A, R_G=10\Omega, V_{GE}=15V, \text{感性负载}, T_C=150^\circ C$	--	34	--	nS
Rise time	t_r		--	36	--	nS
Turn-off delay time	$t_{d(off)}$		--	448	--	nS
Fall time	t_f		--	238	--	nS
Turn-on energy	E_{on}		--	1.1	--	mJ
Turn-off energy	E_{off}		--	3.38	--	mJ
Total switching energy	E_{ts}	--	4.48	--	mJ	
Gate charge	Q_G	$V_{CE}=600V, I_C=40A, V_{GE}=15V$	--	329	--	nC

5.6 Electrical Characteristics (Diode) (Tc=25°C, unless otherwise specified)

Parameter	Symbol	Conditions	Value			Units
			Min	Typ	Max	
Diode forward voltage	V_F	$I_F=40A, T_j=25^\circ C$	--	2.2	3.5	V
		$I_F=40A, T_j=150^\circ C$	--	1.7	--	V
Diode reverse recovery time	t_{rr}	$I_F=0.5A, I_R=1.0A, I_{rr}=0.25A$	--	40	--	ns
Diode reverse recovery	t_{rr}	$I_F=40A, di/dt=200A/\mu S, V_R=400V$	--	86	--	ns
Diode peak reverse	I_{rrm}		--	5.8	--	A
Diode reverse recovery	Q_{rr}		--	280	--	nC
Maximum Instantaneous Reverse	I_R	$V_R=1200V$	--	--	5.0	μA
		$V_R=1200V, T_C=150^\circ C$	--	--	1.0	mA

6 Typical Characteristic Curves

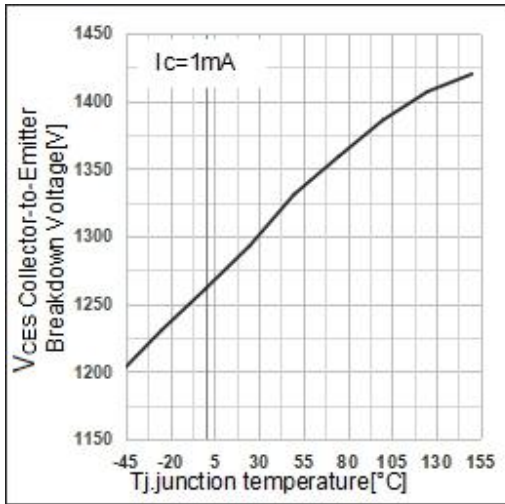

Fig1. Collector-to-Emitter Breakdown Voltage of temperature characteristic

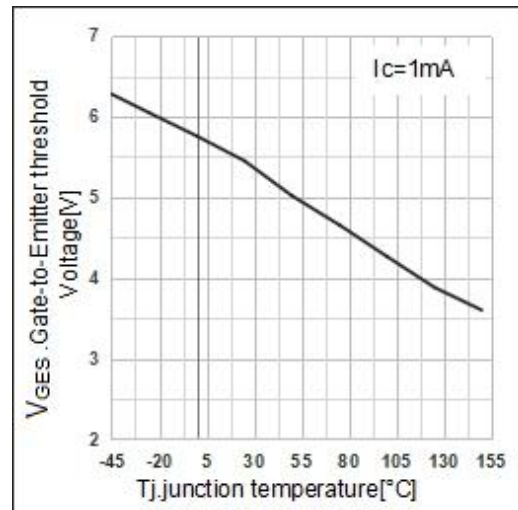

Fig2. Gate-to-Emitter Threshold Voltage of temperature characteristic

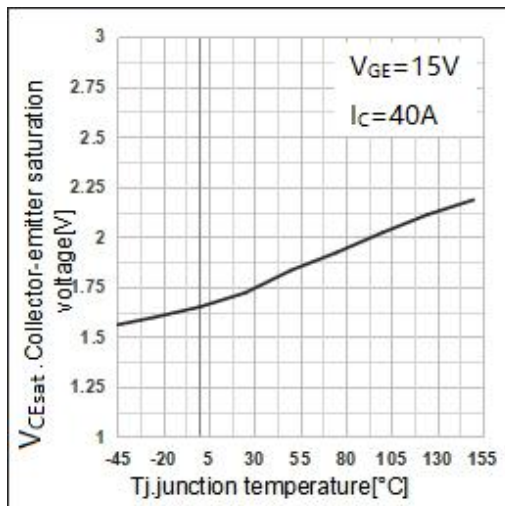

Fig3. Collector-emitter saturation voltage

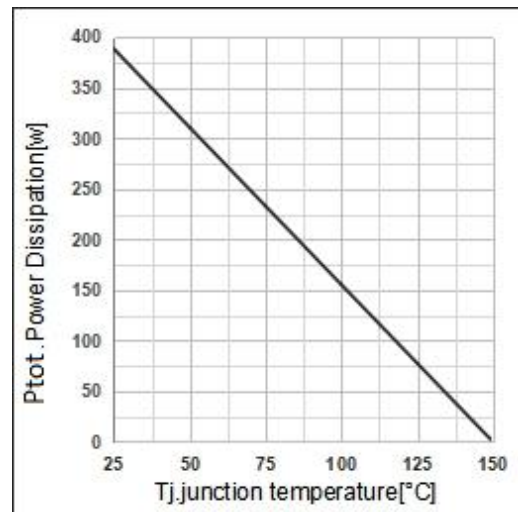

Fig4. Power Dissipation of temperature characteristic

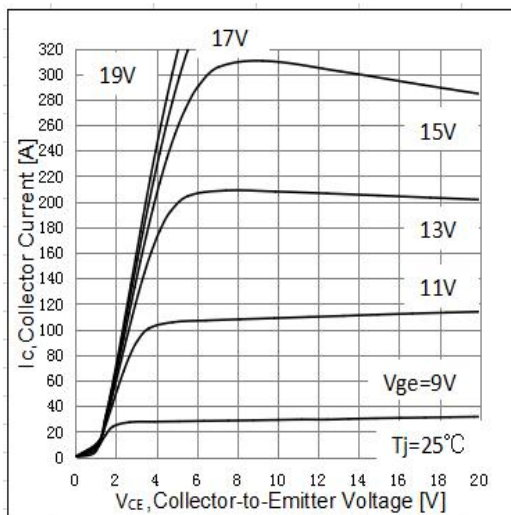

Fig5. Typical output characteristic

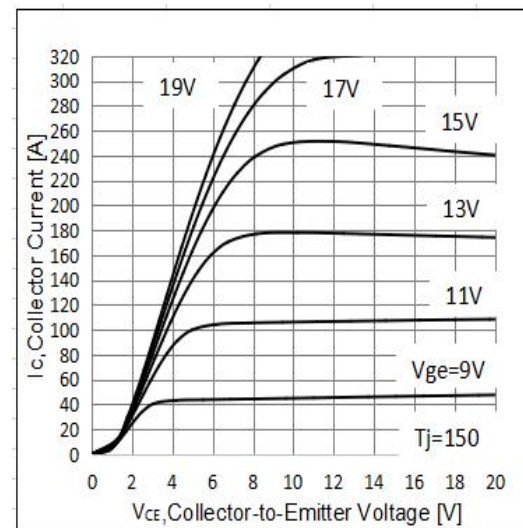

Fig6. Typical output characteristic

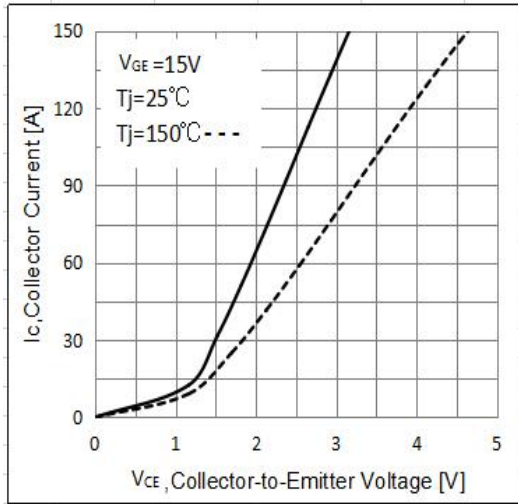

Fig7. Collector-emitter saturation voltage Characteristic

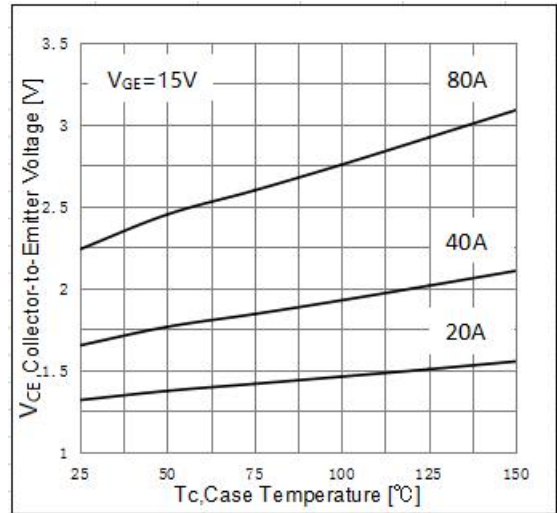

Fig8. Collector-emitter saturation voltage Temperature Characteristic

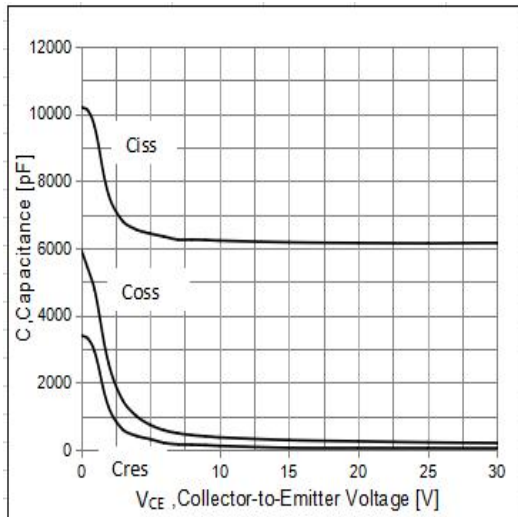

Fig9. Typical capacitance as a function of collector-emitter voltage

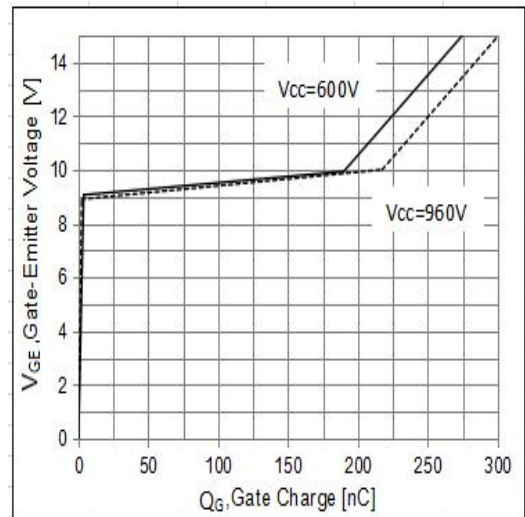

Fig10. Typical gate charge

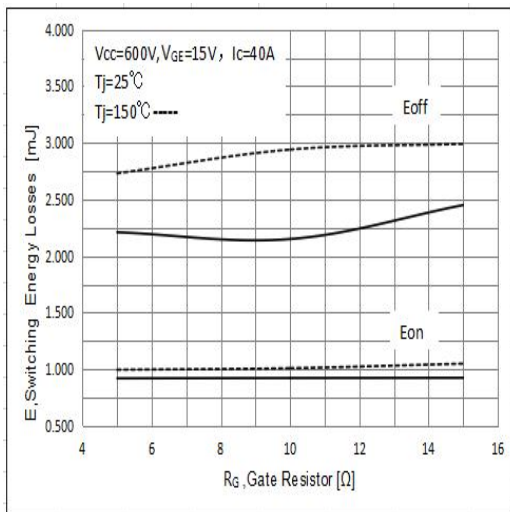

Fig11. Typical switching energy losses as a function of gate resistor

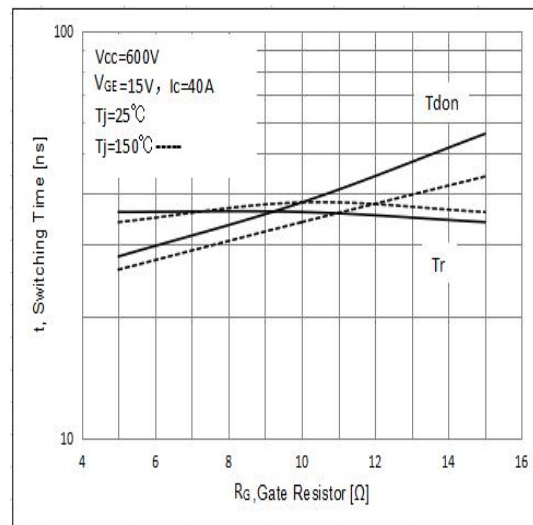

Fig12. Typical switching times as a function of gate resistor

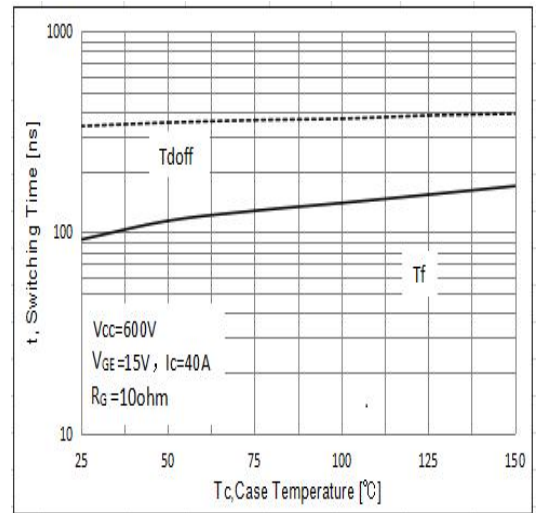
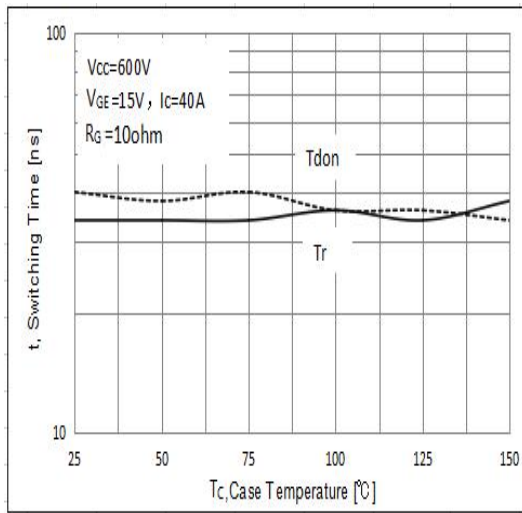
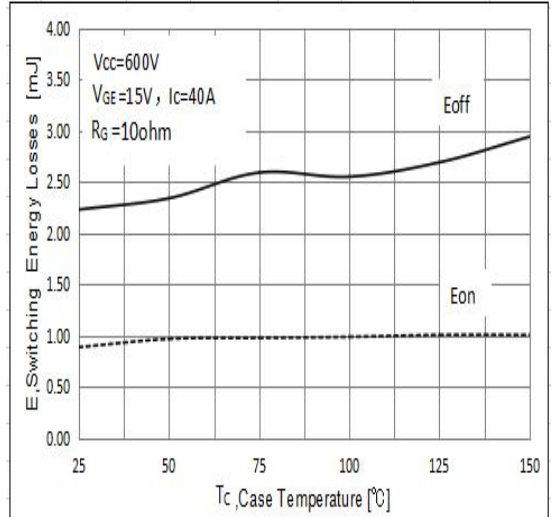
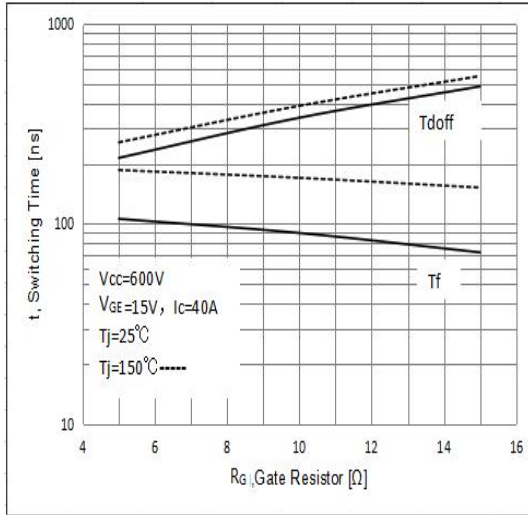

Fig15. Typical switching times as a function of Case Temperature

Fig16. Typical switching times as a function of Case Temperature

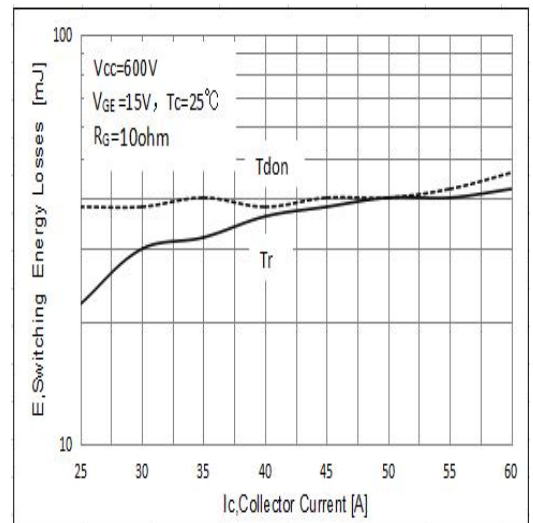
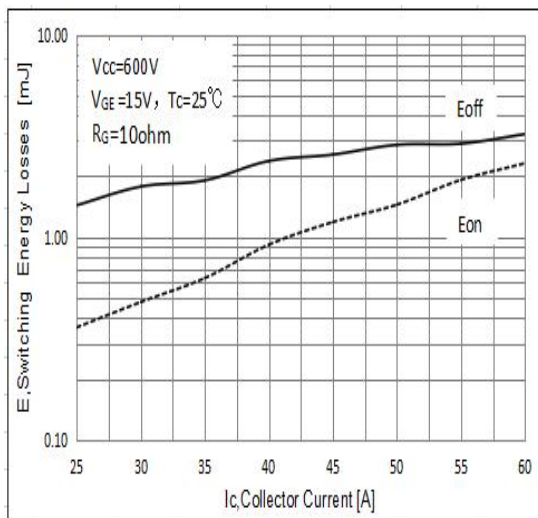

Fig17. Typical switching energy losses as a function of Collector Current

Fig18. Typical switching times as a function of Collector Current

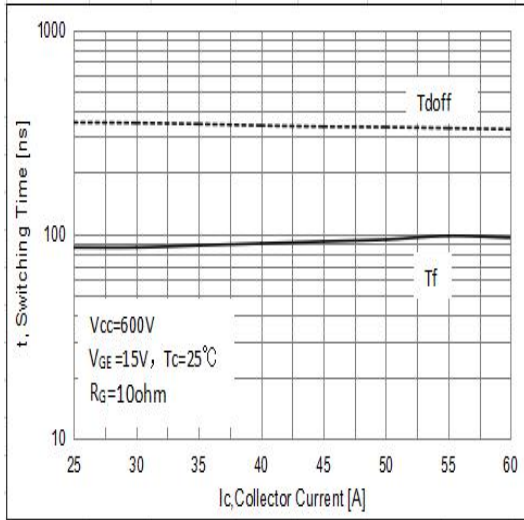

Fig19. Typical switching times as a function of Collector Current

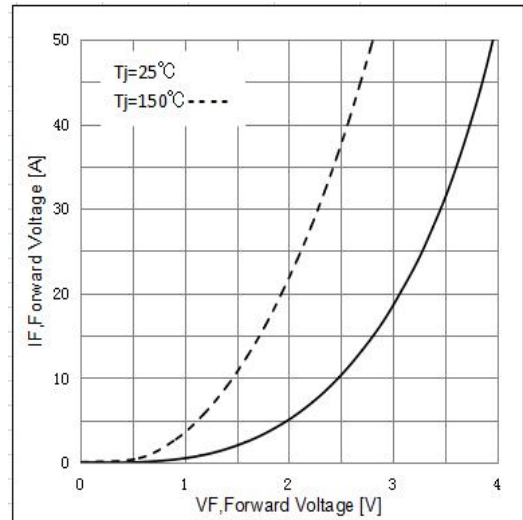

Fig20. Typical diode forward current as a function of forward voltage

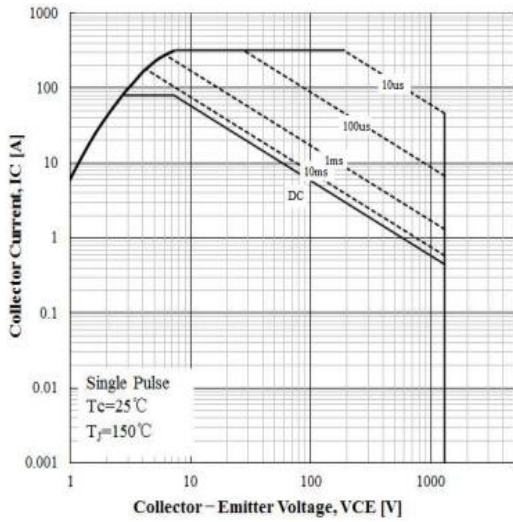

Fig21. Forward bias safe operating area

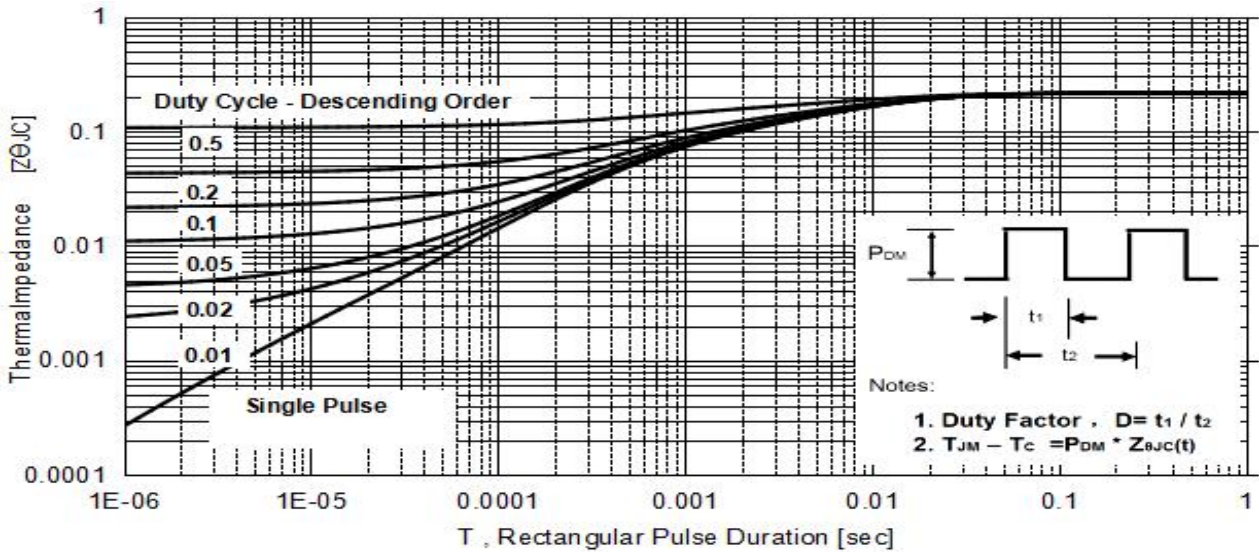

Fig22. IGBT transient thermal resistance

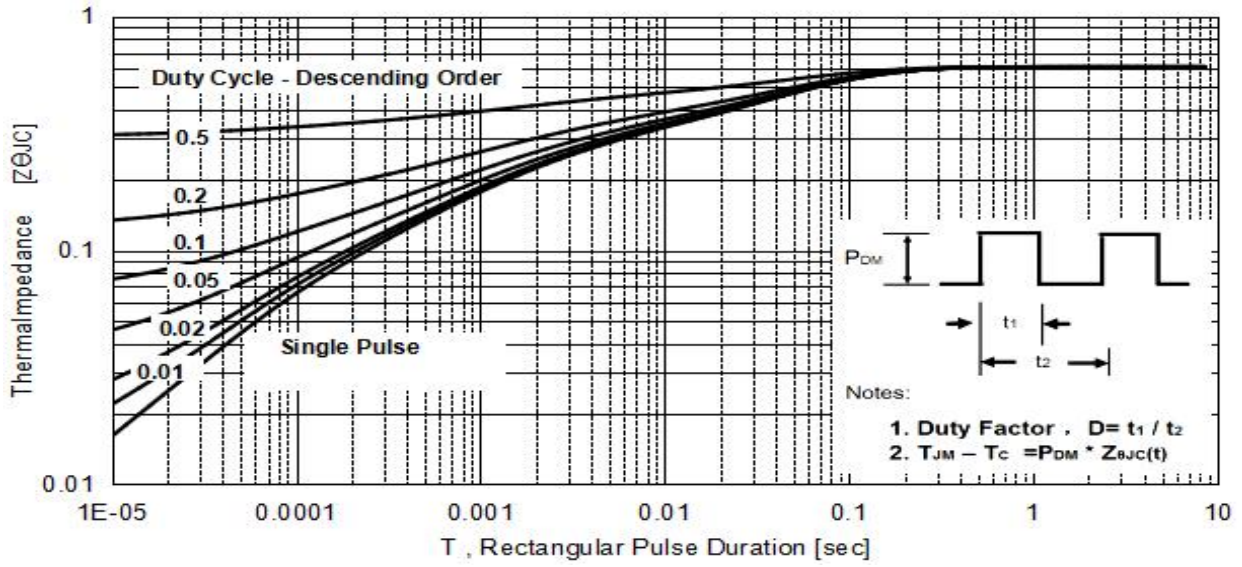
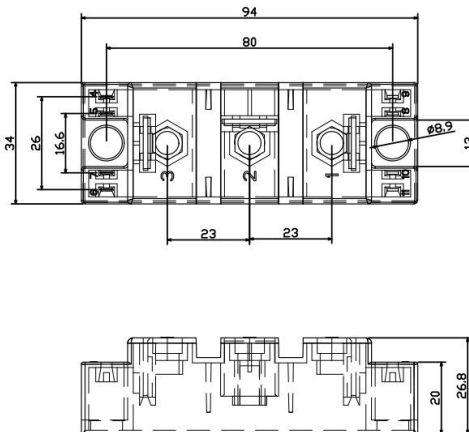
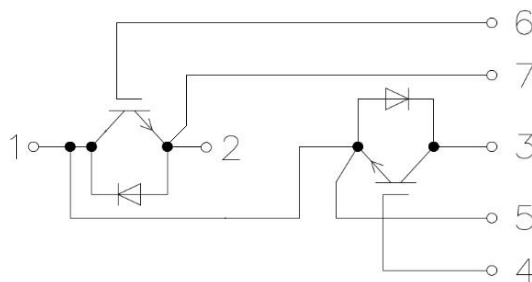

Fig23.Diode transient thermal resistance

7 Dimensions



7.1 Circuit Schematic



8 Attentions

- Jiangsu Donghai Semiconductor Technology CO.,LTD. reserves the right to change the specification without prior notice! The customer should obtain the latest version of the information before making the order and verify that the information is complete and up to date.
- It is the responsibility of the purchaser for any failure or failure of any semiconductor product under certain conditions. It is the responsibility of the purchaser to comply with safety standards and to take safety measures in the system design and machine manufacturing of Donghai products in order to avoid potential risk of failure. Injury or property damage.
- Product promotion is endless, our company will be dedicated to provide customers with better products.

9 Appendix

Revision history:

Date	REV.	Description	Page
2023.12.12	1.0	Original	